



GLOBALHOOK®

PRESENTATION _2
CUSTOMIZED SOLUTIONS _7
MATERIALS _8

STANDARD HOOKS _11

C-TYPE _11
C90-TYPE _12
C180-TYPE _13

V-TYPE _14
V90-TYPE _15
V180-TYPE _16

LC-TYPE _17
LC90-TYPE _18
LC180-TYPE _19

LV-TYPE _20
LV90-TYPE _21
LV180-TYPE _22

CV-TYPE _23
CV90-TYPE _24
CV180-TYPE _25

SQUARE WIRE HOOKS _26

SQ-TYPE _26

TUBE HOOKS _27

TUBE-A _27
TUBE-B _27
TUBE-C _28
TUBE-R _28

LOAD HOOKS _29

LOAD TYPE _29

VERTICAL LINE HOOKS _30

VERT _30
VERT90 _30

METRIC _31

EYEBOLTS _31
CAPS _31
THREAD METRIC HOOKS _32

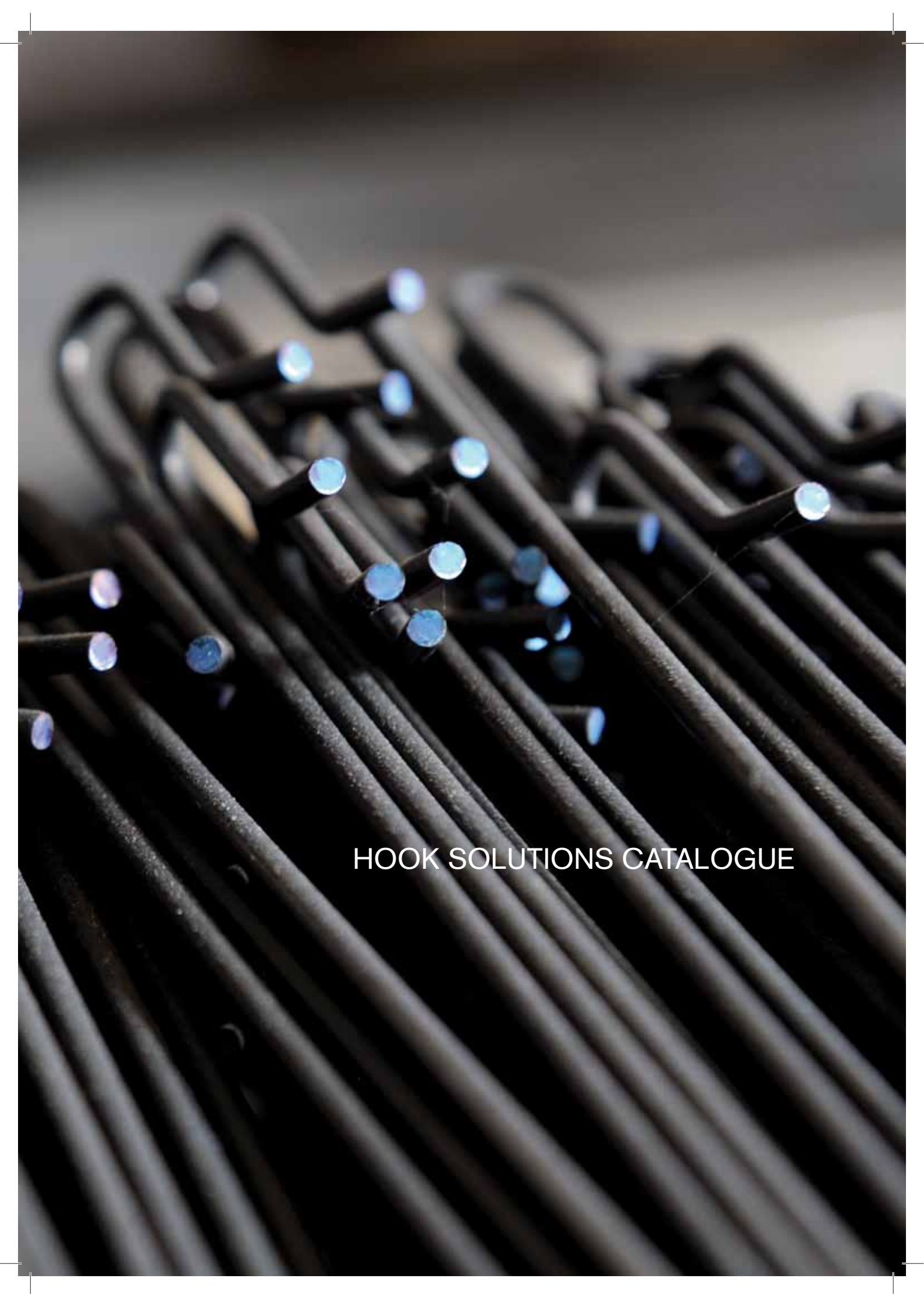

HOOK SOLUTIONS CATALOGUE

GLOBALHOOK® is the commercial brand used by Molles Malé SL to launch the new standardized line of wire products to the European Market.

Molles Malé, with more than 50 years designing and producing customized wire products wants now to launch a new catalogue with the most common hooks, frames and racks.

From the beginning we have been investing in the newest technologies and it allows us to offer the best quality, a good service and an efficient way to give solutions to our customers' needs.

Our product range is involved in many different sectors such as the coating industries, the textile companies or the agricultural sector between others.

Our main product lines are Compression Springs, Extension Springs, Torsion Springs, springs and Strip pieces, Agricultural Springs, Shape Pieces and Coating lines Hooks, but we can design and produce any other line of products.

**Molles Malé, more than 50 years at your service,
more than 50 years solving problems.**

**GLOBALHOOK®, where our expertise meet
your needs.**

HOOKS

FRAMES

RACKS

SPRINGS

STRIP PIECES

SHAPE PIECES

OTHER WIRE PRODUCTS

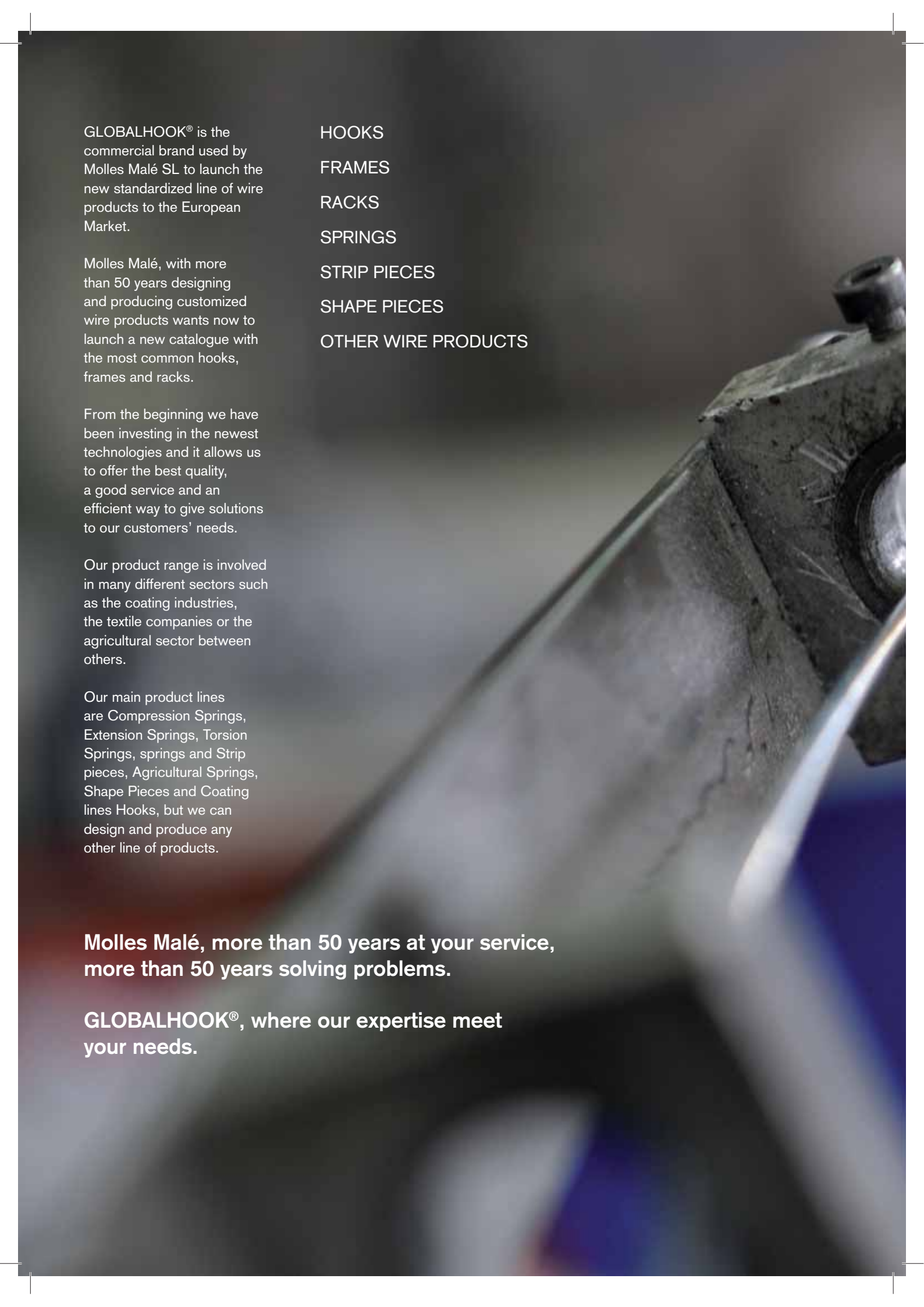



GLOBALHOOK®







GLOBALHOOK®

CUSTOMIZED SOLUTIONS

Let us know the problem you need to solve and we will offer you the best solution. We are specialists on solving particular problems.

Sample 1

How to hang a profile trough an internal slot of a piece in order to avoid marks during the painting process?

Solution

The piece is hanged by the slot using the spring effect of the hook. You only have to introduce the hook into the slot by pressing.

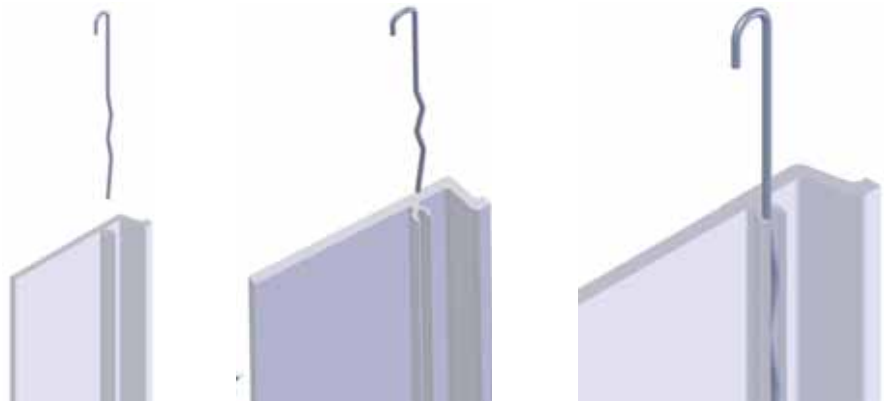

Sample 2

How to hang metallic sheets 600 x 600 x 1 mm avoiding marks during the painting process and improving the performance of the line?

Solution

Using a special frame specially customized for this application. By this frame, the customer hangs 2 metallic sheets easily, taking advantage the measures of their painting line.

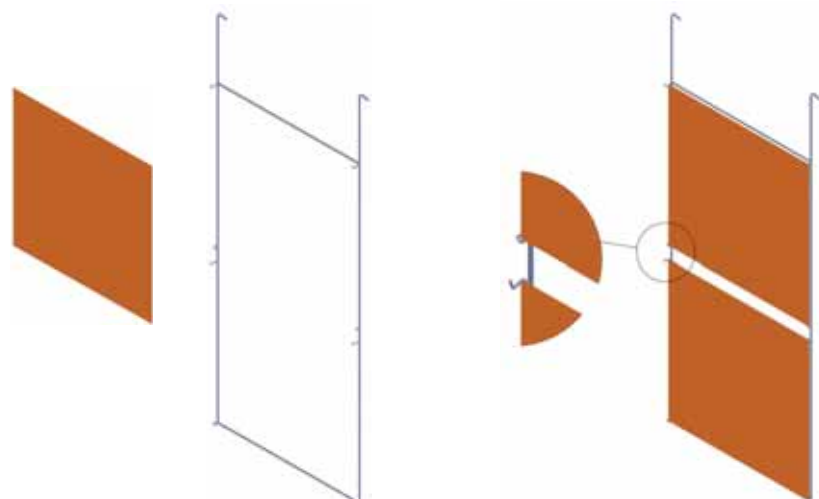

MATERIALS

Different materials are available in our catalogue.

You can find diameters from 0.2 mm to 16 mm and squared wire.

Following you will find our standard materials. Other materials available, ask for more information.

Steel hooks

Most common material used for hooks, frames, etc.
Available diameters: from 0.6 mm to 16 mm.

Coppered steel hooks

Same material than Steel Hooks with copper coating that provides better conductivity, allowing the hooks to have a better grounding when the piece is hanged.

The price for \varnothing 1.5, \varnothing 2, \varnothing 3 and \varnothing 4 is the same than the steel hooks.
Available diameters: 1.5 mm, 2 mm, 3 mm and 4 mm.

Spring steel hooks

Bigger load capacity than steel and coppered hooks (aprox. 50% more strenght).

Spring steel hooks are used in situations where applying pression on the piece to fix is needed. Also allows the use of smaller hook diameters because of the strenght.
Available diameters: from 0.6 mm to 16 mm.

Stainless steel hooks

This material is used to avoid corrosion and increase the life of the hook.
Available diameters: from 2 mm to 10 mm.

Stainless steel spring hooks

Same proprieties of the spring steel and the stainless steel hooks together.
Available diameters: 0.2 mm to 12 mm.





GLOBALHOOK®

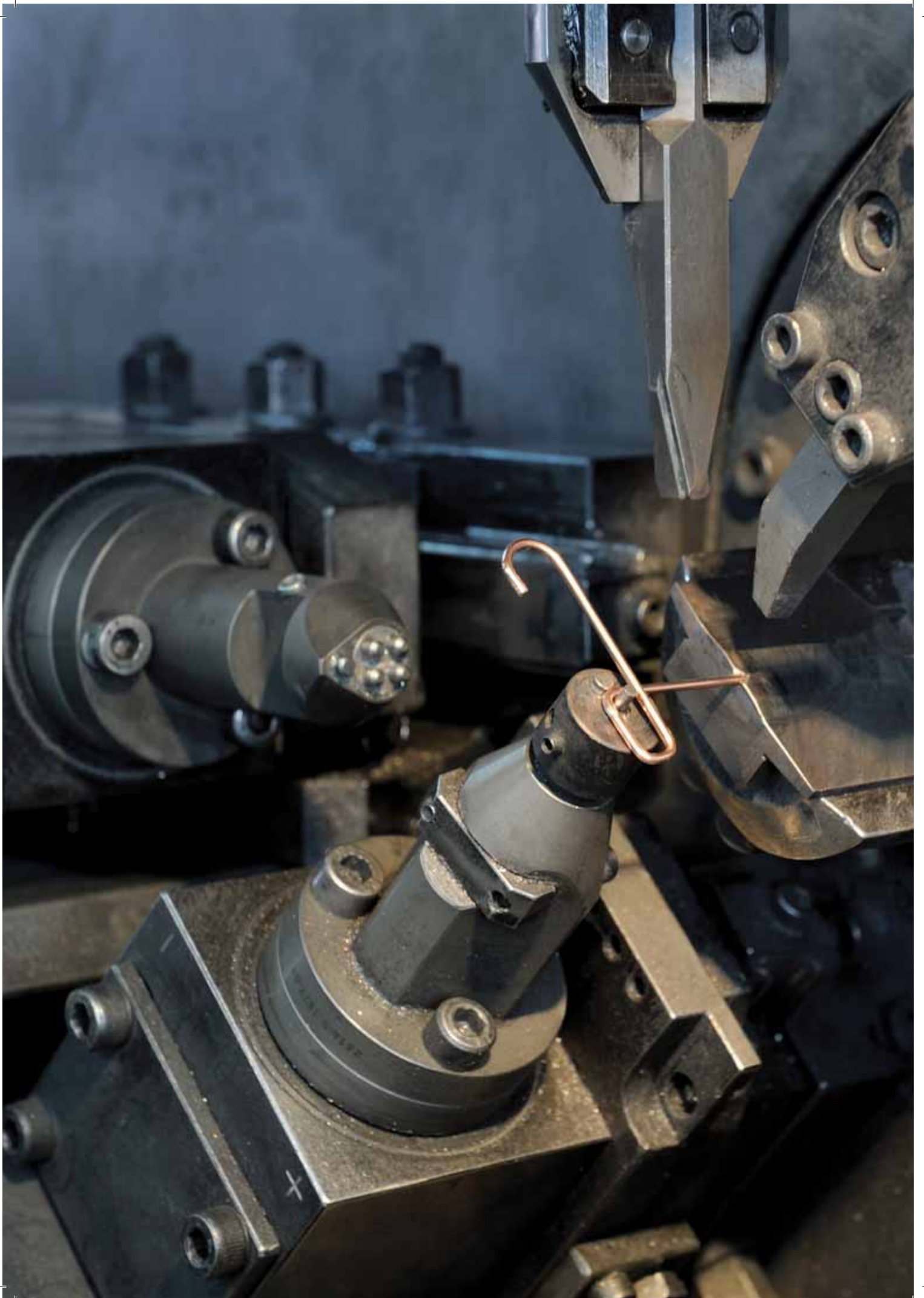

STANDARD HOOKS

C-TYPE

The C type hook is the most versatile hook. Ideal to hang different-shaped pieces.



BOX QUANTITY

Length	ø 1.5	ø 2	ø 3	ø 4	ø 5	ø 6	ø 8
60	5000	5000	3000	1500	1000	800	ns
75	4000	4000	2500	1200	800	600	ns
100	3000	3000	1500	800	600	500	300
120	2000	2000	1000	600	ns	ns	ns
150	2000	1500	1000	500	500	400	250
200	2000	1500	800	500	400	300	200
250	2000	1500	800	500	300	250	150
300	1800	1200	600	400	300	250	150
350	1800	1200	600	400	250	200	125
400	1800	1200	600	400	250	200	125
450	1800	1200	600	400	250	200	125
500	1600	1100	500	350	200	150	100
600	1500	1000	500	300	175	125	75
700	1500	1000	500	300	175	125	75
800	1500	1000	500	300	175	125	75
900	1400	900	400	250	175	125	75
1000	1300	800	400	250	150	100	60

Measures in millimeters

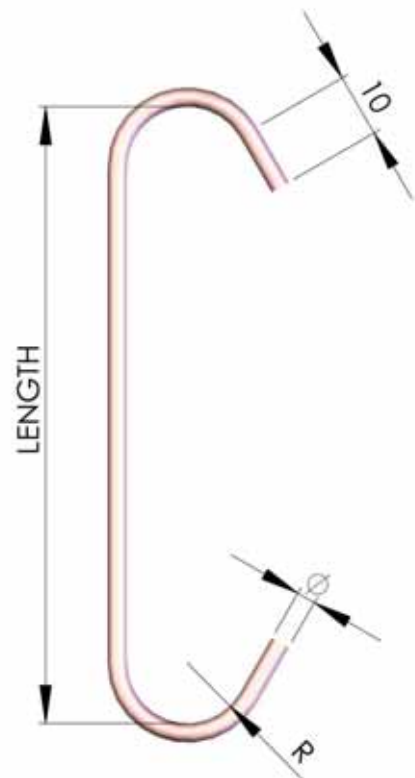

	ø 1.5 mm	ø 2 mm	ø 3 mm	ø 4 mm
R (mm)	8	8	10	10

Ask for different diameters from 0.6 to 16 mm and different lengths.
 Different angles are available.
 Minimum quantity per order: 1 box.
 Made of coppered steel from wire 1.5 mm to wire 4 mm and are also available in other materials.
 The hooks with a wire diameter of 5 mm or more are made of steel.

STANDARD HOOKS

C90-TYPE

The C type hook is the most versatile hook.
Ideal to hang different-shaped pieces.
The 90° changes the orientation of the hanged piece.



BOX QUANTITY

Length	ø 1.5	ø 2	ø 3	ø 4	ø 5	ø 6	ø 8
60	3700	3700	2200	1100	750	600	ns
75	3000	3000	1800	900	600	450	ns
100	2200	1100	1100	600	450	375	225
120	1500	1500	700	400	ns	ns	ns
150	1500	1100	700	300	375	300	175
200	1500	1100	600	300	300	225	150
250	1500	1100	600	300	225	175	100
300	1300	900	400	300	225	175	100
350	1300	900	400	300	175	150	75
400	1300	900	400	300	175	150	75
450	1300	900	400	300	175	150	75
500	1200	800	300	200	150	100	75
600	1100	700	300	200	125	75	50
700	1100	700	300	200	125	75	50
800	1100	700	300	200	125	75	50
900	1000	600	300	100	125	75	50
1000	900	600	300	100	100	75	45

Measures in millimeters

Ask for different diameters from 0.6 to 16 mm and different lengths.
Different angles are available.
Minimum quantity per order: 1 box.
Made of coppered steel from wire 1.5 mm to wire 4 mm and are also available in other materials.
The hooks with a wire diameter of 5 mm or more are made of steel.

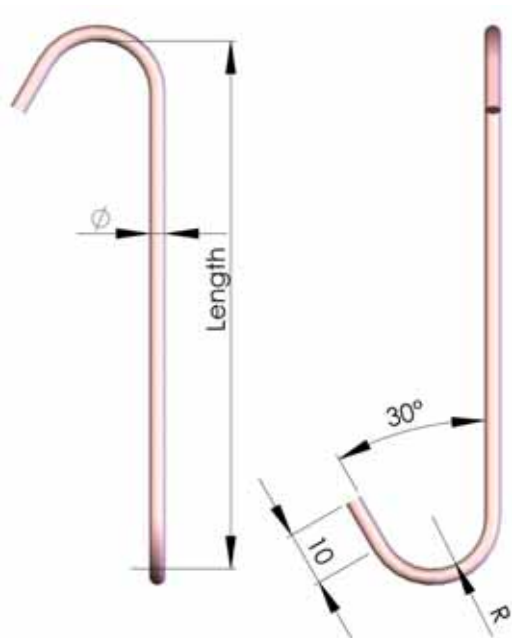
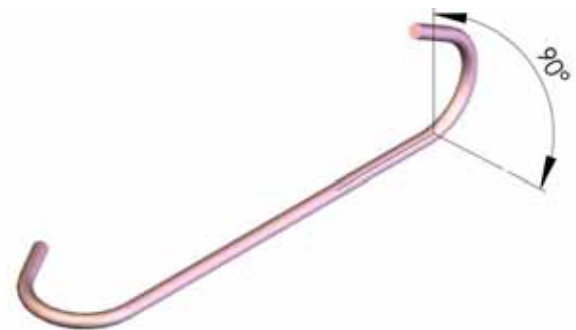

	ø 1.5 mm	ø 2 mm	ø 3 mm	ø 4 mm
R (mm)	8	8	10	10

STANDARD HOOKS

C180-TYPE

The C type hook is the most versatile hook. Ideal to hang different-shaped pieces. The 180° adds new possibilities to distribute the pieces on the rack optimizing the process.

DESIGNATION
C180-3-100

TYPE OF HOOK | LENGTH OF THE HOOK (mm)
| Ø OF THE HOOK (mm)

BOX QUANTITY

Length	ø 1.5	ø 2	ø 3	ø 4	ø 5	ø 6	ø 8
60	4500	4500	2700	1300	900	700	ns
75	3600	3600	2200	1000	700	500	ns
100	2700	2700	1300	700	500	450	250
120	1800	1800	900	500	ns	ns	ns
150	1800	1300	900	400	450	350	225
200	1800	1300	700	400	350	250	175
250	1800	1300	700	400	250	225	125
300	1600	1000	500	300	250	225	125
350	1600	1000	500	300	225	175	100
400	1600	1000	500	300	225	175	100
450	1600	1000	500	300	225	175	100
500	1400	900	400	300	175	125	75
600	1300	900	400	200	150	100	50
700	1300	900	400	200	150	100	50
800	1300	900	400	200	150	100	50
900	1200	800	300	200	150	100	50
1000	1100	700	300	200	125	75	50

Measures in millimeters

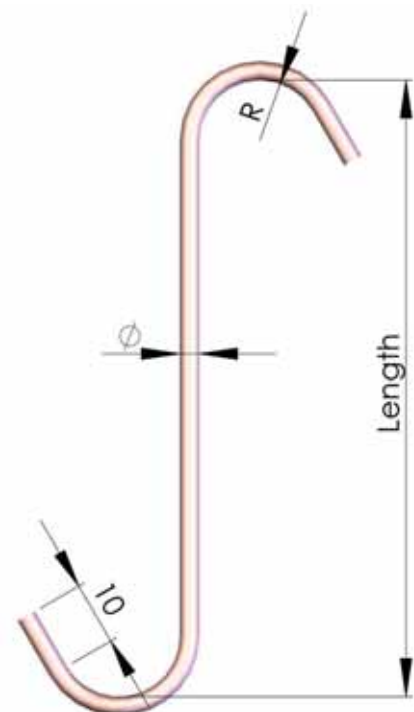

	ø 1.5 mm	ø 2 mm	ø 3 mm	ø 4 mm
R (mm)	8	8	10	10

Ask for different diameters from 0.6 to 16 mm and different lengths. Different angles are available. Minimum quantity per order: 1 box. Made of coppered steel from wire 1.5 mm to wire 4 mm and are also available in other materials. The hooks with a wire diameter of 5 mm or more are made of steel.

STANDARD HOOKS

V-TYPE

This kind of hooks give a better stability when loading than other geometries.
 The V shape provides to this hook a unique contact point with the piece. As a result, conductivity is much better than in the other hook shapes and the possibility of a coating buildup is minimized.



BOX QUANTITY

Length	ø 1.5	ø 2	ø 3	ø 4	ø 5	ø 6	ø 8
60	5000	5000	3000	1500	1000	800	ns
75	4000	4000	2500	1200	800	600	ns
100	3000	3000	1500	800	600	500	300
120	2000	2000	1000	600	ns	ns	ns
150	2000	1500	1000	500	500	400	250
200	2000	1500	800	500	400	300	200
250	2000	1500	800	500	300	250	150
300	1800	1200	600	400	300	250	150
350	1800	1200	600	400	250	200	125
400	1800	1200	600	400	250	200	125
450	1800	1200	600	400	250	200	125
500	1600	1100	500	350	200	150	100
600	1500	1000	500	300	175	125	75
700	1500	1000	500	300	175	125	75
800	1500	1000	500	300	175	125	75
900	1400	900	400	250	175	125	75
1000	1300	800	400	250	150	100	60

Measures in millimeters

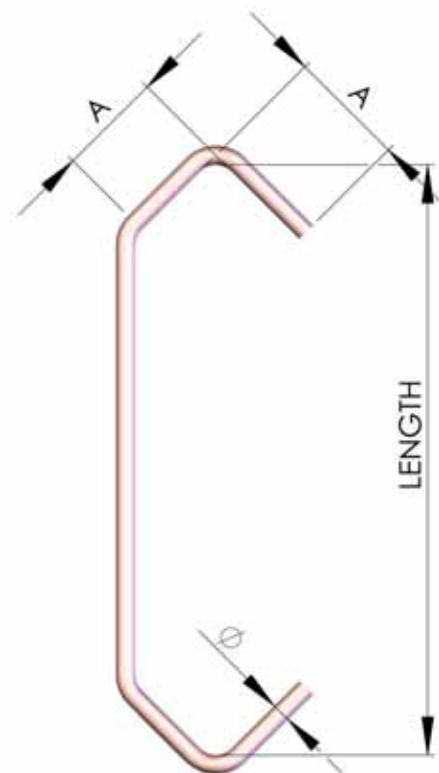

	ø 1.5 mm	ø 2 mm	ø 3 mm	ø 4 mm
A (mm)	15	15	20	20

Ask for different diameters from 0.6 to 16 mm and different lengths.
 Different angles are available.
 Minimum quantity per order: 1 box.
 Made of coppered steel from wire 1.5 mm to wire 4 mm and are also available in other materials.
 The hooks with a wire diameter of 5 mm or more are made of steel.

STANDARD HOOKS

LC90-TYPE

The LC90 type combines the strength of the L shape at the top hanging point with the features of a C90 type hook.

DESIGNATION
LC90-3-100

TYPE OF HOOK | LENGTH OF THE HOOK (mm)
| Ø OF THE HOOK (mm)

BOX QUANTITY

Length	ø 1.5	ø 2	ø 3	ø 4	ø 5	ø 6	ø 8
60	3700	3700	2200	1100	750	600	ns
75	3000	3000	1800	900	600	450	ns
100	2200	1100	1100	600	450	375	225
120	1500	1500	700	400	ns	ns	ns
150	1500	1100	700	300	375	300	175
200	1500	1100	600	300	300	225	150
250	1500	1100	600	300	225	175	100
300	1300	900	400	300	225	175	100
350	1300	900	400	300	175	150	75
400	1300	900	400	300	175	150	75
450	1300	900	400	300	175	150	75
500	1200	800	300	200	150	100	75
600	1100	700	300	200	125	75	50
700	1100	700	300	200	125	75	50
800	1100	700	300	200	125	75	50
900	1000	600	300	100	125	75	50
1000	900	600	300	100	100	75	45

Measures in millimeters

Ask for different diameters from 0.6 to 16 mm and different lengths.
Different angles are available.
Minimum quantity per order: 1 box.
Made of coppered steel from wire 1.5 mm to wire 4 mm and are also available in other materials.
The hooks with a wire diameter of 5 mm or more are made of steel.

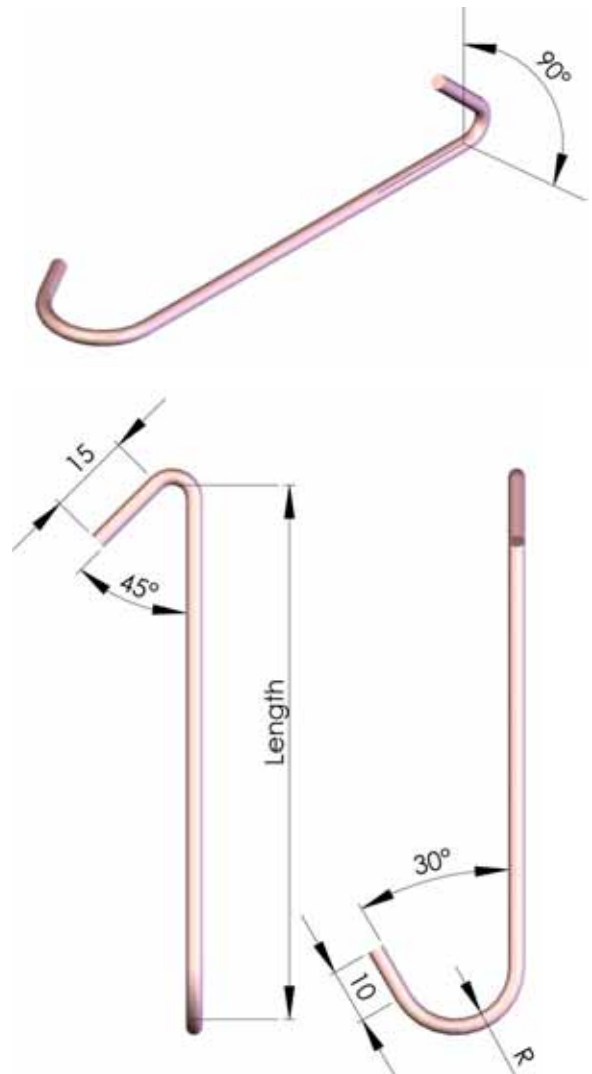

	ø 1.5 mm	ø 2 mm	ø 3 mm	ø 4 mm
A (mm)	15	15	20	20
R (mm)	8	8	10	10

STANDARD HOOKS

LC180-TYPE

The LC180 type combines the strength of the L shape at the top hanging point with the features of a C180 type hook.

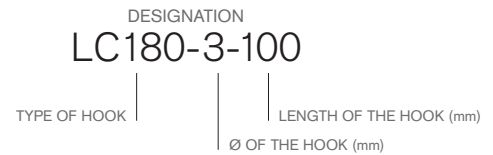

BOX QUANTITY

Length	ø 1.5	ø 2	ø 3	ø 4	ø 5	ø 6	ø 8
60	4500	4500	2700	1300	900	700	ns
75	3600	3600	2200	1000	700	500	ns
100	2700	2700	1300	700	500	450	250
120	1800	1800	900	500	ns	ns	ns
150	1800	1300	900	400	450	350	225
200	1800	1300	700	400	350	250	175
250	1800	1300	700	400	250	225	125
300	1600	1000	500	300	250	225	125
350	1600	1000	500	300	225	175	100
400	1600	1000	500	300	225	175	100
450	1600	1000	500	300	225	175	100
500	1400	900	400	300	175	125	75
600	1300	900	400	200	150	100	50
700	1300	900	400	200	150	100	50
800	1300	900	400	200	150	100	50
900	1200	800	300	200	150	100	50
1000	1100	700	300	200	125	75	50

Measures in millimeters

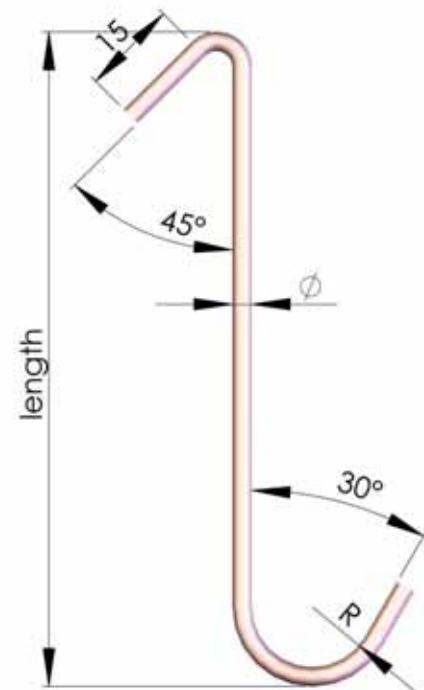

	ø 1.5 mm	ø 2 mm	ø 3 mm	ø 4 mm
R (mm)	8	8	10	10

Ask for different diameters from 0.6 to 16 mm and different lengths.
 Different angles are available.
 Minimum quantity per order: 1 box.
 Made of coppered steel from wire 1.5 mm to wire 4 mm and are also available in other materials.
 The hooks with a wire diameter of 5 mm or more are made of steel.

STANDARD HOOKS

LV-TYPE

The LV type combines the strongest shape at the top hanging point with the features of V type: it allows a better conductivity because it makes the piece to be allocated always in the same contact point on the hook.



BOX QUANTITY

Length	ø 1.5	ø 2	ø 3	ø 4	ø 5	ø 6	ø 8
60	5000	5000	3000	1500	1000	800	ns
75	4000	4000	2500	1200	800	600	ns
100	3000	3000	1500	800	600	500	300
120	2000	2000	1000	600	ns	ns	ns
150	2000	1500	1000	500	500	400	250
200	2000	1500	800	500	400	300	200
250	2000	1500	800	500	300	250	150
300	1800	1200	600	400	300	250	150
350	1800	1200	600	400	250	200	125
400	1800	1200	600	400	250	200	125
450	1800	1200	600	400	250	200	125
500	1600	1100	500	350	200	150	100
600	1500	1000	500	300	175	125	75
700	1500	1000	500	300	175	125	75
800	1500	1000	500	300	175	125	75
900	1400	900	400	250	175	125	75
1000	1300	800	400	250	150	100	60

Measures in millimeters

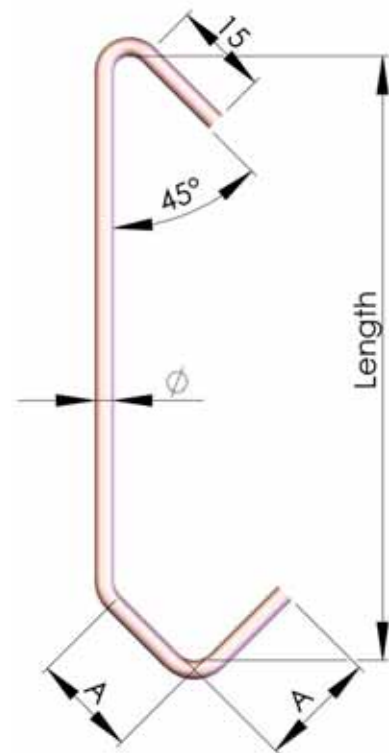

	ø 1.5 mm	ø 2 mm	ø 3 mm	ø 4 mm
A (mm)	15	15	20	20

Ask for different diameters from 0.6 to 16 mm and different lengths.
Different angles are available.
Minimum quantity per order: 1 box.
Made of coppered steel from wire 1.5 mm to wire 4 mm and are also available in other materials.
The hooks with a wire diameter of 5 mm or more are made of steel.

STANDARD HOOKS

LV180-TYPE

The LC type combines the strongest shape at the top with the features of a V180 hook: better conductivity and unique laying point on the hook.

DESIGNATION
LV180-3-100

TYPE OF HOOK | LENGTH OF THE HOOK (mm)
| Ø OF THE HOOK (mm)

BOX QUANTITY

Length	ø 1.5	ø 2	ø 3	ø 4	ø 5	ø 6	ø 8
60	4500	4500	2700	1300	900	700	ns
75	3600	3600	2200	1000	700	500	ns
100	2700	2700	1300	700	500	450	250
120	1800	1800	900	500	ns	ns	ns
150	1800	1300	900	400	450	350	225
200	1800	1300	700	400	350A	250	175
250	1800	1300	700	400	250	225	125
300	1600	1000	500	300	250	225	125
350	1600	1000	500	300	225	175	100
400	1600	1000	500	300	225	175	100
450	1600	1000	500	300	225	175	100
500	1400	900	400	300	175	125	75
600	1300	900	400	200	150	100	50
700	1300	900	400	200	150	100	50
800	1300	900	400	200	150	100	50
900	1200	800	300	200	150	100	50
1000	1100	700	300	200	125	75	50

Measures in millimeters

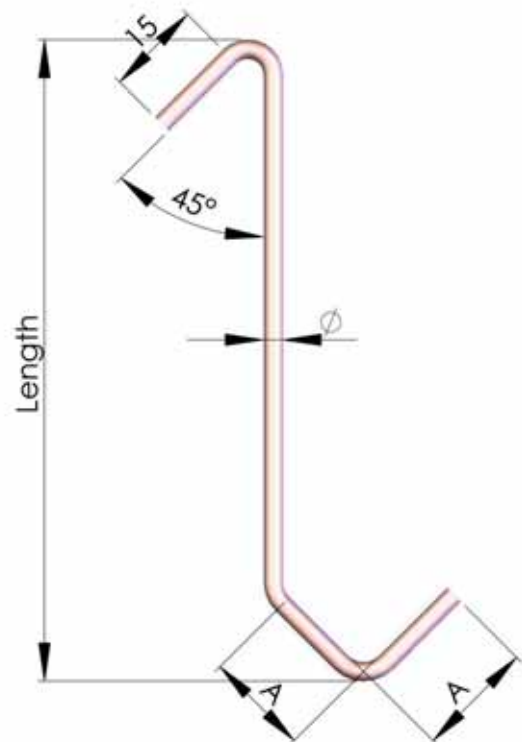

	ø 1.5 mm	ø 2 mm	ø 3 mm	ø 4 mm
A (mm)	15	15	20	20

Ask for different diameters from 0.6 to 16 mm and different lengths.
 Different angles are available.
 Minimum quantity per order: 1 box.
 Made of coppered steel from wire 1.5 mm to wire 4 mm and are also available in other materials.
 The hooks with a wire diameter of 5 mm or more are made of steel.

STANDARD HOOKS

CV-TYPE

The CV type combines the features of V-type with the easy use of C-type.



BOX QUANTITY

Length	ø 1.5	ø 2	ø 3	ø 4	ø 5	ø 6	ø 8
60	5000	5000	3000	1500	1000	800	ns
75	4000	4000	2500	1200	800	600	ns
100	3000	3000	1500	800	600	500	300
120	2000	2000	1000	600	ns	ns	ns
150	2000	1500	1000	500	500	400	250
200	2000	1500	800	500	400	300	200
250	2000	1500	800	500	300	250	150
300	1800	1200	600	400	300	250	150
350	1800	1200	600	400	250	200	125
400	1800	1200	600	400	250	200	125
450	1800	1200	600	400	250	200	125
500	1600	1100	500	350	200	150	100
600	1500	1000	500	300	175	125	75
700	1500	1000	500	300	175	125	75
800	1500	1000	500	300	175	125	75
900	1400	900	400	250	175	125	75
1000	1300	800	400	250	150	100	60

Measures in millimeters

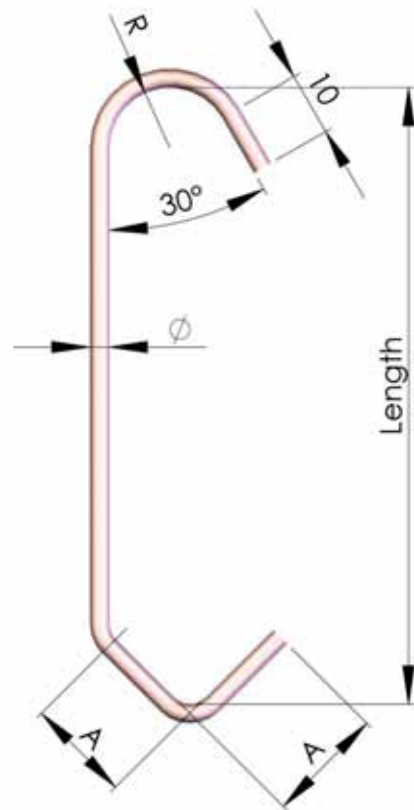

	ø 1.5 mm	ø 2 mm	ø 3 mm	ø 4 mm
A (mm)	15	15	20	20
R (mm)	8	8	10	10

Ask for different diameters from 0.6 to 16 mm and different lengths.
 Different angles are available.
 Minimum quantity per order: 1 box.
 Made of coppered steel from wire 1.5 mm to wire 4 mm and are also available in other materials.
 The hooks with a wire diameter of 5 mm or more are made of steel.

STANDARD HOOKS

CV90-TYPE

The CV type 90° combines the features of V-type with the easy use of C-type and the 90° advantages.

DESIGNATION
CV90-3-100

TYPE OF HOOK | LENGTH OF THE HOOK (mm)
| Ø OF THE HOOK (mm)

BOX QUANTITY

Length	ø 1.5	ø 2	ø 3	ø 4	ø 5	ø 6	ø 8
60	3700	3700	2200	1100	750	600	ns
75	3000	3000	1800	900	600	450	ns
100	2200	1100	1100	600	450	375	225
120	1500	1500	700	400	ns	ns	ns
150	1500	1100	700	300	375	300	175
200	1500	1100	600	300	300	225	150
250	1500	1100	600	300	225	175	100
300	1300	900	400	300	225	175	100
350	1300	900	400	300	175	150	75
400	1300	900	400	300	175	150	75
450	1300	900	400	300	175	150	75
500	1200	800	300	200	150	100	75
600	1100	700	300	200	125	75	50
700	1100	700	300	200	125	75	50
800	1100	700	300	200	125	75	50
900	1000	600	300	100	125	75	50
1000	900	600	300	100	100	75	45

Measures in millimeters

Ask for different diameters from 0.6 to 16 mm and different lengths.
Different angles are available.
Minimum quantity per order: 1 box.
Made of coppered steel from wire 1.5 mm to wire 4 mm and are also available in other materials.
The hooks with a wire diameter of 5 mm or more are made of steel.

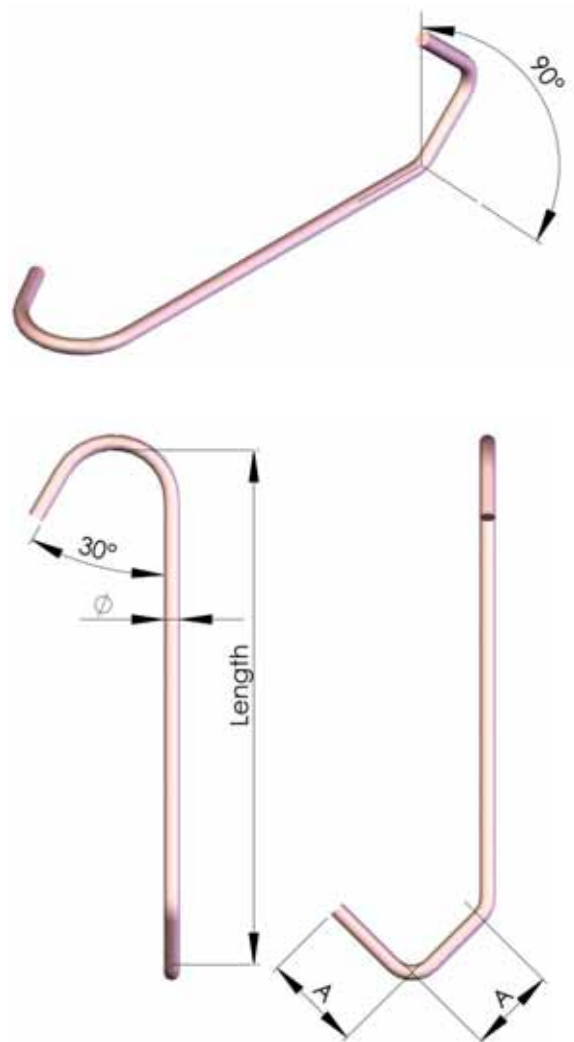

	ø 1.5 mm	ø 2 mm	ø 3 mm	ø 4 mm
A (mm)	15	15	20	20
R (mm)	8	8	10	10

STANDARD HOOKS

CV180-TYPE

The CV type combines the features of V-type with the easy use of C-type and the additional advantages of the 180° angle.

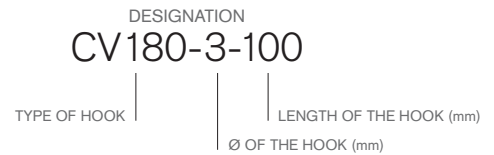

BOX QUANTITY

Length	ø 1.5	ø 2	ø 3	ø 4	ø 5	ø 6	ø 8
60	4500	4500	2700	1300	900	700	ns
75	3600	3600	2200	1000	700	500	ns
100	2700	2700	1300	700	500	450	250
120	1800	1800	900	500	ns	ns	ns
150	1800	1300	900	400	450	350	225
200	1800	1300	700	400	350	250	175
250	1800	1300	700	400	250	225	125
300	1600	1000	500	300	250	225	125
350	1600	1000	500	300	225	175	100
400	1600	1000	500	300	225	175	100
450	1600	1000	500	300	225	175	100
500	1400	900	400	300	175	125	75
600	1300	900	400	200	150	100	50
700	1300	900	400	200	150	100	50
800	1300	900	400	200	150	100	50
900	1200	800	300	200	150	100	50
1000	1100	700	300	200	125	75	50

Measures in millimeters

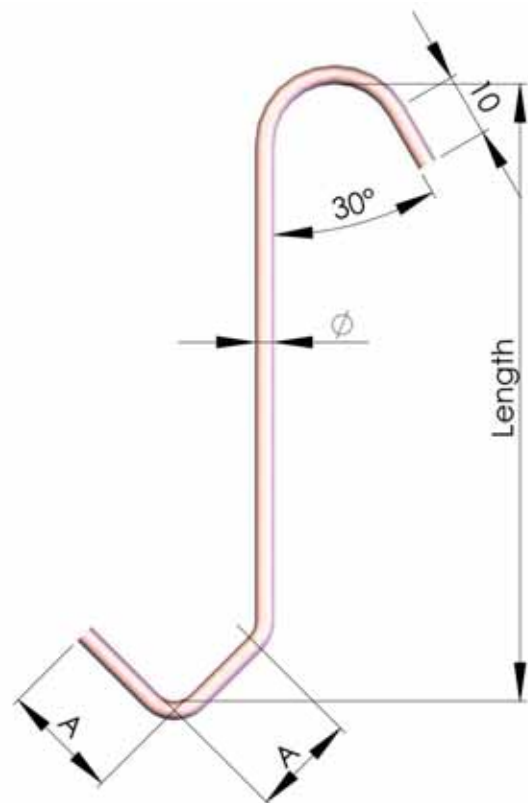

	ø 1.5 mm	ø 2 mm	ø 3 mm	ø 4 mm
A (mm)	15	15	20	20
R (mm)	8	8	10	10

Ask for different diameters from 0.6 to 16 mm and different lengths.
 Different angles are available.
 Minimum quantity per order: 1 box.
 Made of coppered steel from wire 1.5 mm to wire 4 mm and are also available in other materials.
 The hooks with a wire diameter of 5 mm or more are made of steel.

SQUARE WIRE HOOKS

SQ-TYPE

Made by spring steel.
 It provides better grounding than rounded wire.
 The squared wire is almost twice stronger than the same dimension in rounded wire.



BOX QUANTITY

Length	S=3	S=4	S=5	S=6
75	1200	800	700	ns
100	800	600	500	300
120	600	550	400	250
150	500	500	350	250
200	500	400	300	200
250	500	300	200	150
300	400	300	200	150
350	400	250	150	225
400	400	250	150	125
450	400	250	150	125
500	350	200	100	100
600	300	175	100	75
700	300	175	100	75
800	300	175	100	75
900	250	175	100	75
1000	250	150	75	60

Measures in millimeters

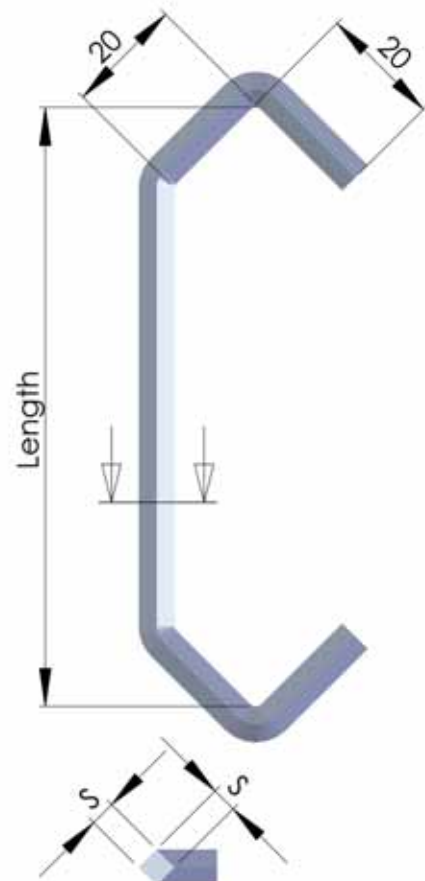

Ask for different wire side and different lengths.
 Different angles and shapes available.
 Minimum order quantity: 1 box.

TUBE HOOKS

This kind of hook allows to hang the piece through a hole and keep the external side of the piece free of marks after painting. Made with spring steel, this hook uses the spring effect to fix the hook in the piece.

TUBE-A

Made with spring steel \varnothing 2 mm. The hook fixes and remove inside the horizontal bar pressing the leg.

BOX QUANTITY

TUBEA-2-15-150	500
TUBEA-2-20-150	500
TUBEA-2-25-150	500
TUBEA-3-30-200	500



TUBE-B

The Tube-B type allows to avoid scratches on the internal side of the hole (pressing the leg of the hook while placing and removing).

Let us know the dimension of the hole, the diameter of the wire you want and the hook length you need and we will design a special tube-B hook for you.

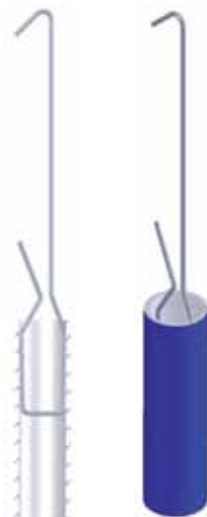

TUBE HOOKS

This kind of hooks allow to hang the piece through a hole and keep the external side of the piece free of marks after painting. Made by spring steel, this hooks use the spring effect to fix the hook with the piece.

TUBE-C

Let us know the dimension of the hole, the wire diameter and the length of the hook and we design a special hook for you.

Only for cylindrical holes.

Used to hang and mask at the same time.

Turn the hook for introduce and remove the hook.

BOX QUANTITY

TUBEA-2-15-150	500
TUBEA-2-20-150	500
TUBEA-2-25-150	500
TUBEA-3-30-200	500



DESIGNATION
TUBEC25-2-100

TYPE OF HOOK | HOLE DIMENSION (mm) | WIRE DIAMETER (mm) | LENGTH (mm)

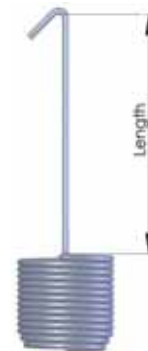

TUBE-R

Standardized tube hooks.
The most versatile tube hooks.

TUBE-R

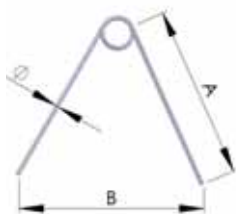

BOX QUANTITY

ø 1	ø 1,5	ø 2	ø 3
1000	1000	500	500

Measures in millimeters

TUBE-RL

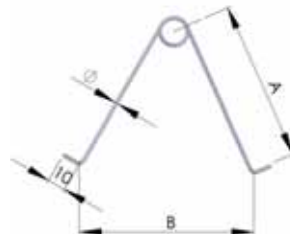

BOX QUANTITY

	ø 1	ø 1,5	ø 2	ø 3
A	40	70	85	100
B	40	60	85	85

Measures in millimeters

DESIGNATION TUBER-2

TYPE OF HOOK | WIRE DIAMETER (mm)

LOAD HOOK

LOAD TYPE

This hooks are made to hang big weight pieces.
 Made by steel.
 You can combine diferent ends and angles.

DESIGNATION
LOADC-10-250

TYPE OF HOOK | LENGTH OF THE HOOK (mm)
 | Ø OF THE HOOK (mm)

BOX QUANTITY

	ø 10mm	ø 12mm	ø 14mm	ø 16mm
R (mm)	11	11	15	25
A (mm)	30	32	34	36

LOADV TYPE

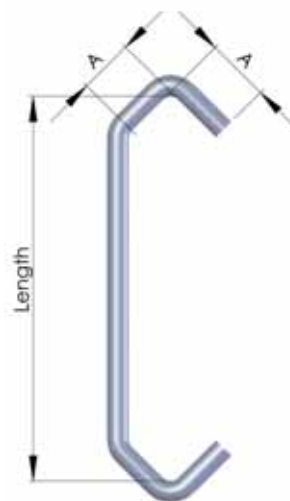

LOADC TYPE

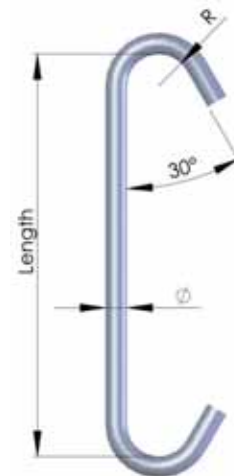

BOX QUANTITY

Length	ø 10	ø 12	ø 14	ø 16
100	100	100	-	-
150	100	100	75	75
200	75	75	50	50
250	50	50	50	50
300	50	50	50	40
350	50	50	50	25
400	50	50	50	25
450	50	50	25	20
500	50	50	25	20

Measures in millimeters

Ask for diferent diferent lengths.
 Diferent angles availables.
 Minimum order quantity: 1 box.
 Made by steel, available in other materials.

LOADCV TYPE



LOADLV TYPE

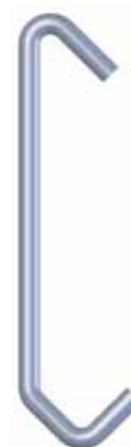

VERTICAL LINE HOOKS

This hooks are specially developed for the vertical powder coating lines, which paint aluminium profiles.
 Made by hardened spring steel in order to fix the profiles strongly (the profiles to be painted usually measure from 4 to 7 meters length). The most standardized vertical line hook is $\varnothing 3 \times 685$ mm length (500 units/box).

Minimum order quantity: 1 box.
 Made by hardened steel, available in other materials.
 Custom diameter and length available.

VERT

DESIGNATION
VERT-3-685

TYPE OF HOOK			LENGTH OF THE HOOK (mm)
			Ø OF THE HOOK (mm)

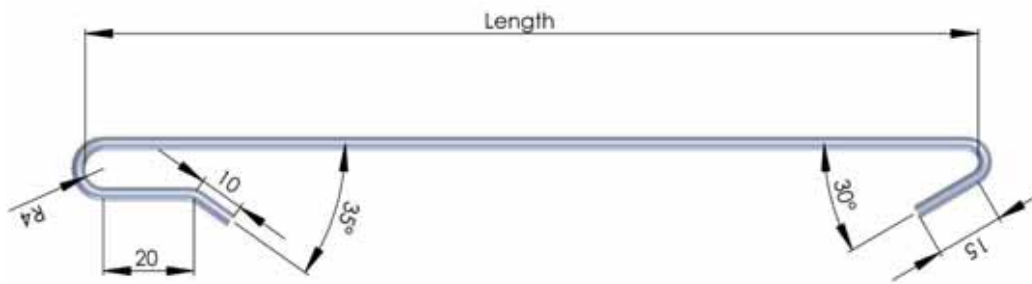

VERT90

DESIGNATION
VERT-3-685-90

ALSO AVAILABLE IN DIFFERENT ANGLES

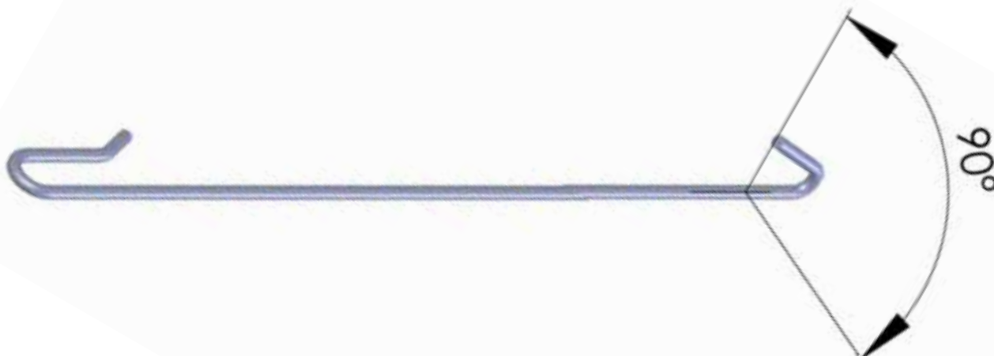

METRIC

METRIC EYEBOLTS

This kind of hooks fix pieces by the female metric thread of a piece.

DESIGNATION
EYE-M10

TYPE OF HOOK | KIND OF THREAD

BOX QUANTITY

	Ø (mm)	A (mm)	
EYE-M3	500	5	10
EYE-M4	500	6	10
EYE-M5	500	8	10
EYE-M6	500	10	10
EYE-M8	250	12	12
EYE-M10	250	14	14
EYE-M12	100	16	16

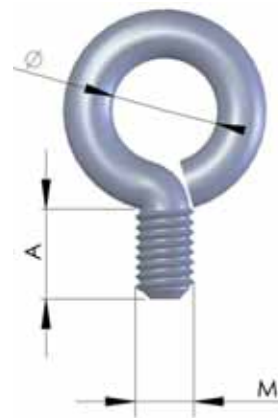

METRIC CAPS

This kind of hooks fix pieces by the male metric thread of a piece.

DESIGNATION
CAP-M10

TYPE OF HOOK | KIND OF THREAD

BOX QUANTITY

	Ø (mm)	A (mm)	
CAP-M3	500	3	5
CAP-M4	400	3	8
CAP-M5	200	4	13
CAP-M6	100	5	15
CAP-M8	50	6	15
CAP-M10	25	8	20
CAP-M12	25	10	25
CAP-M14	25	12	25
CAP-M16	25	14	25
CAP-M18	25	16	25
CAP-M20	25	18	25



METRIC

THREAD METRIC HOOKS

This kind of hooks are designed to fix the pieces on the male thread part of a piece. Pressing at the leg, the internal diameter of the spring increases allowing to introduce the male thread through the spring. Once the male thread is introduced, the piece is fixed when you stop pressing the leg.

DESIGNATION
THREAD-M10

TYPE OF END | KIND OF THREAD

BOX QUANTITY

	Ø wire (mm)	QTY	A	B
THREAD-M3	1	500	50	18
THREAD-M4	1	500	60	20
THREAD-M5	1.2	500	70	30
THREAD-M6	1.2	500	95	40
THREAD-M8	1.5	250	95	40
THREAD-M10	1.8	250	95	40
THREAD-M12	2	100	95	40
THREAD-M14	2.5	100	95	40
THREAD-M16	2.5	100	95	40

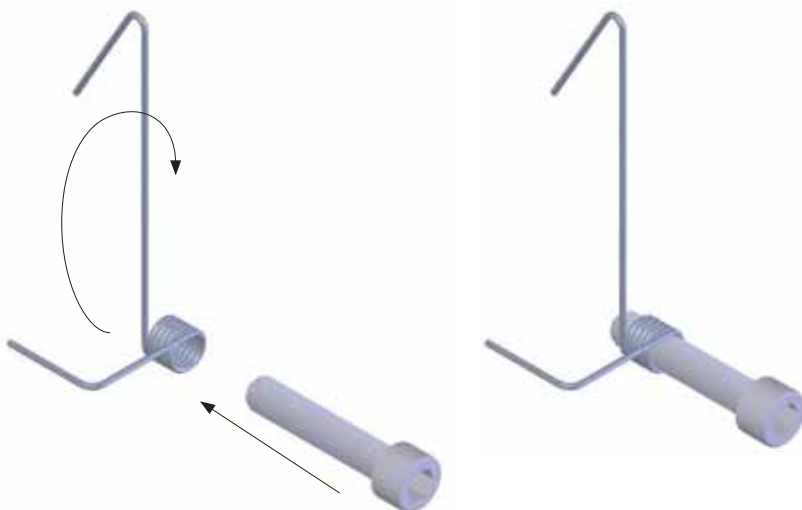
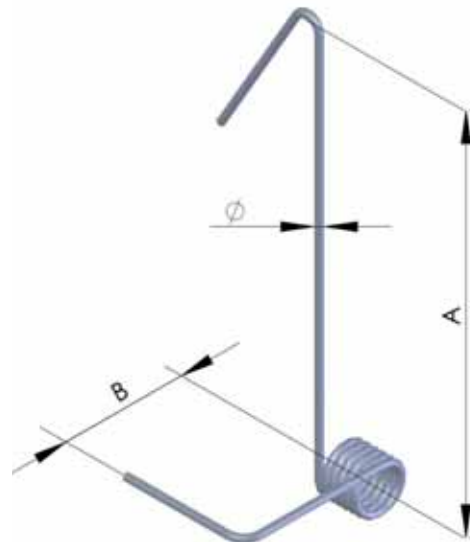

Ask for diferent dimensions.
 Diferent angles are availables
 Minimum quantity per order:
 1 box.
 Material: Spring steel.

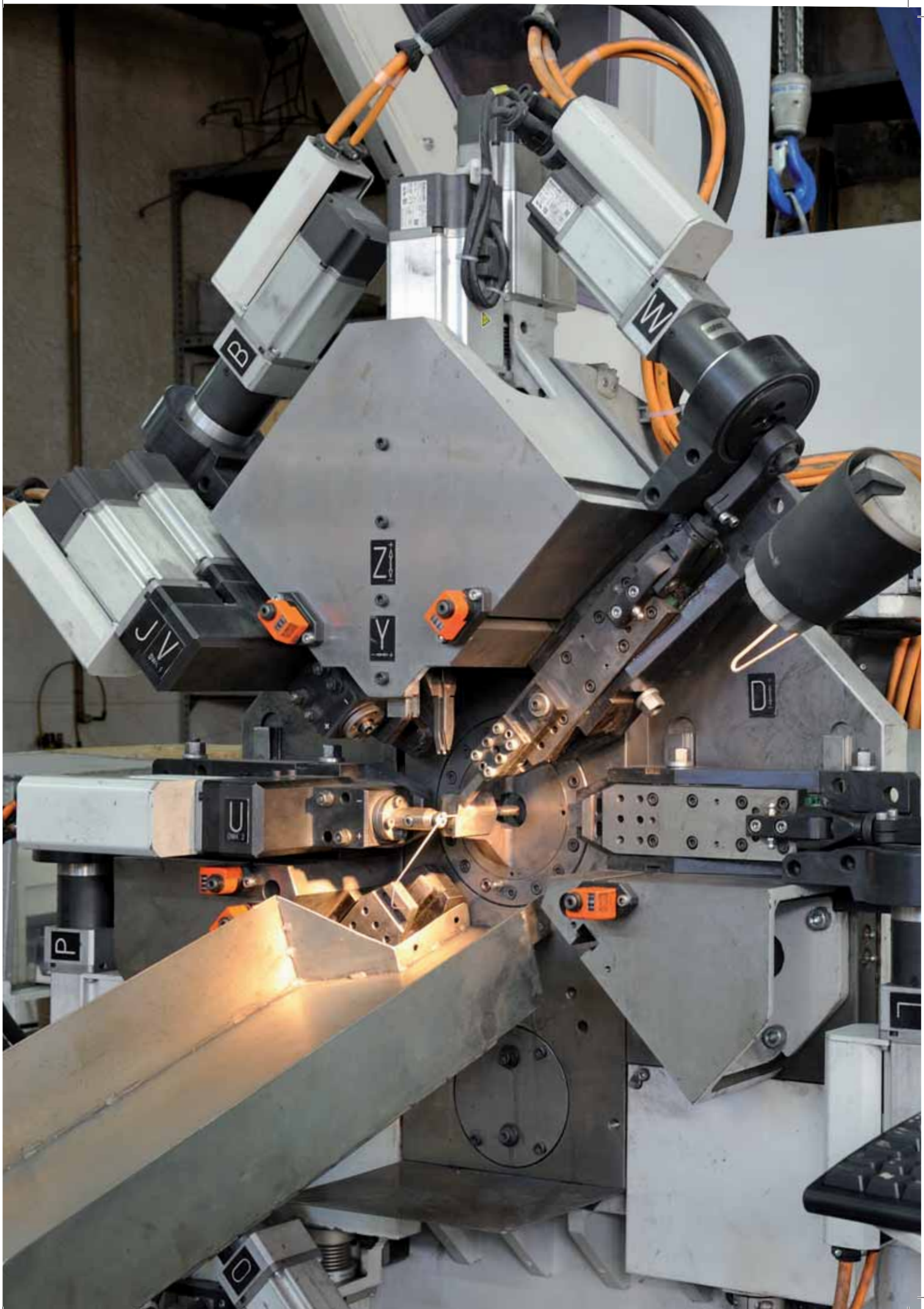



CONTACT DETAILS: